

Article number: 51030445000010

Description: Vibration damper GS-M2
100x30x2000-10, NR shore 57

Measures

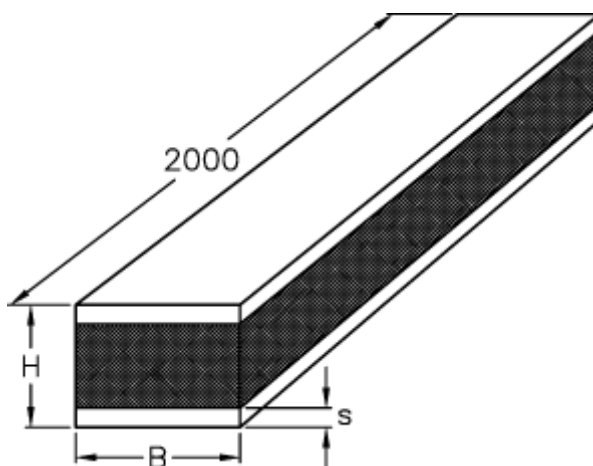

B = 100
H = 30
S = 10